



Accessories

CL272



Electronic lock

Handle lock



Cylinder lock

Main material and finish: Black PA hinge, steel screw, PC shaft
Application: Opening angle 160°

Plane lock

Rod control lock

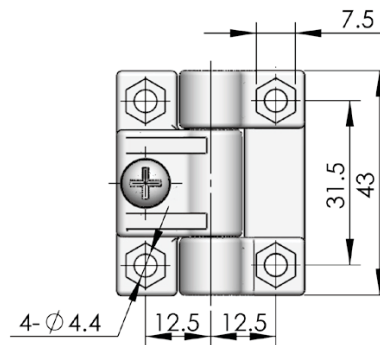
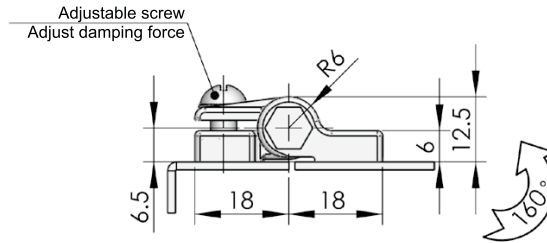

ERP

CL272N00001

Panel lock

CL272-2



Toggle and hook

Handles



Door stop

Main material and finish: POM black male and female hinge transparent PC shaft, and Stainless steel adjustable screw and nut.
Application: Maximum rotating angle 165°

Hinge

Seal gasket

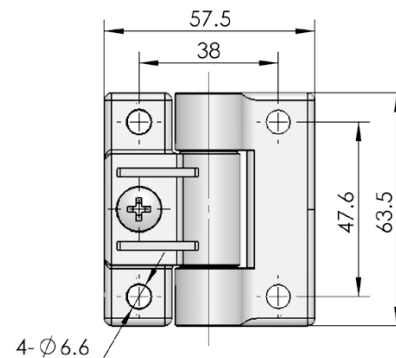
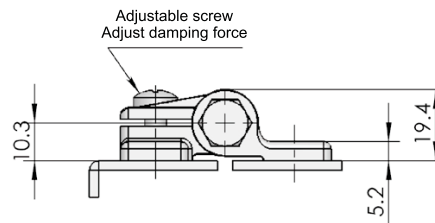

ERP

CL272N00002